



PAPER-1(B.E./B. TECH.)

JEE (Main) 2021

Questions & Solutions

(Reproduced from memory retention)

Date : 26 February, 2021 (SHIFT-2) Time ; (3.00 pm to 06.00 pm)

Duration : 3 Hours | Max. Marks : 300

SUBJECT : PHYSICS

2nd Flood, Grand Plaza, Fraser Road, Dak Banglow, Patna - 800001

Tel. : + 8448446676 | Website : www.vidyapeethacademy.com

PHYSICS

1. Which of the following graph represents the relation between velocity and displacement for a body performing SHM.

- (1) Ellipse (2) Circle (3) Hyperbola (4) Helix

Ans. (1)

Sol. $v = \omega\sqrt{A^2 - x^2}$
 $\frac{v^2}{A^2\omega^2} + \frac{x^2}{A^2} = 1$

∴ Ellipse is the correct graph.

2. **Statement (1) :-** Time period of second's pendulum is 1 sec.

Statement (2) :- Time taken between two extreme positions in second's pendulum is 1 sec.

(1) Statement (1) is correct, statement-(2) is correct but not correct explanation.

(2) Statement (1) is correct, statement (2) is correct and it is correct explanation.

(3) Statement (1) is correct, statement (2) is wrong.

(4) Statement (1) is wrong and statement (2) is also wrong.

Ans. (1)

3. A particle is thrown in air, following trajectory $y = \alpha x - \beta x^2$, where α and β are constant, x and y are horizontal line and vertical line respectively. It's angle of projection and maximum height

- (1) $\tan^{-1}(\alpha), \frac{4\alpha^2}{\beta}$ (2) $\tan^{-1}(\alpha), \frac{\alpha^2}{4\beta}$ (3) $\tan^{-1}(\beta), \frac{\beta^2}{4\alpha}$ (4) $\tan^{-1}(\beta), \frac{\beta}{4\alpha}$

Ans. (2)

Sol. For $y_{\text{max}} \Rightarrow \frac{dy}{dx} = \alpha - 2\beta x = 0$

$$x = \frac{\alpha}{2\beta}$$

$$y_{\text{max}} = H_{\text{max}} = \alpha \times \frac{\alpha}{2\beta} - \beta \left(\frac{\alpha}{2\beta} \right)^2$$

$$= \frac{\alpha^2}{2\beta} - \frac{\alpha^2}{4\beta} = \left(\frac{\alpha^2}{4\beta} \right)$$

$$2x = R = \frac{\alpha}{\beta} = \frac{2u^2 \sin \theta \cos \theta}{g}$$

$$H = \frac{\alpha^2}{4\beta} = \frac{u^2 \sin^2 \theta}{2g}$$

$$\tan \theta = \alpha$$

$$\theta = \tan^{-1} (\alpha)$$

4. Cord is wrapped around a wheel in vertical plane and it can rotate about horizontal axis. At the end of string a block of weight mg is attached. System is released from rest. Find square of angular frequency when block descends by height h .

(1) $\frac{2mgh}{I+mR^2}$ (2) $\frac{mgh}{I+2mR^2}$ (3) $\frac{2mgh}{I+2mR^2}$ (4) $\frac{mgh}{I+mR^2}$

Ans. (1)

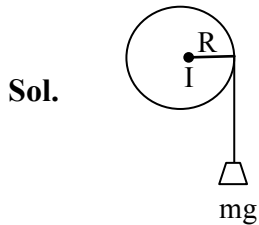

$$mg - T = ma$$

$$TR = I\alpha$$

$$a = R\alpha$$

$$mg - \frac{I\alpha}{R} = ma$$

$$a = \frac{mg}{m + \frac{I}{R^2}}$$

$$V = \sqrt{\frac{2mgh}{m + \frac{I}{R^2}}} = \omega R$$

$$\omega^2 = \frac{2mgh}{I + mR^2}$$

5. H-atom is free to move and it's electron is in state $n = 5$. Find recoil speed of atom when electron jumps from $n = 5$ to $n = 1$

(1) 4.35 m/sec (2) 1.2 m/sec (3) 13.06 m/sec (4) 0.435 m/sec

Ans. (1)

Sol. $E_1 = -\frac{13.6 \text{ eV}}{1^2} = -13.6 \text{ eV}$

$$E_5 = -\frac{13.6 \text{ eV}}{25} = -0.54 \text{ eV}$$

$$E_5 - E_1 = 13.6 - 0.54 = 13.06 \text{ eV}$$

$$\text{recoil speed} = \frac{\Delta E}{CM} = \frac{13.06 \text{ eV}}{3 \times 10^{-8} \times 1.6 \times 10^{-27}}$$

$$= \frac{13.06 \times 1.6 \times 10^{-19}}{3 \times 1.6 \times 10^{-19}}$$

$$= \frac{13.06}{3} = 4.35 \text{ m/sec}$$

6. Find dimensional formula of λ if $\lambda = \frac{C}{V}$ (where, C = capacity ; V = Voltage)
 (1) $[M^{-3}L^{-3}T^7A^3]$ (2) $[M^{-2}L^{-2}T^7A^3]$ (3) $[M^{-1}L^{-2}T^7A^{-3}]$ (4) $[M^3L^3T^7A^{-3}]$

Ans. (1)

Sol.
$$[\lambda] = \frac{[C]}{[V]} = \frac{[M^{-1}L^{-2}T^4A^2]}{[M^2LT^{-3}A^{-1}]}$$

$$= [M^{-3}L^{-3}T^7A^3]$$

7. Activity of a sample is A at time t_1 . If it's activity is $\frac{A}{5}$ at time t_2 then find the average life.

- (1) $\frac{t_2 - t_1}{\ln 5}$ (2) $\frac{\ln 5}{t_2 - t_1}$ (3) $\frac{\ln 5}{t_2 + t_1}$ (4) $\frac{t_2 + t_1}{\ln 5}$

Ans. (1)

Sol. $A = A_0 e^{-\lambda t}$ (Radio active decay law)

$$\frac{A}{5} = Ae^{-\lambda(t_2 - t_1)}$$

$$\ln 5 = \lambda (t_2 - t_1)$$

$$\frac{1}{\lambda} = \frac{t_2 - t_1}{\ln 5}$$

8. For given R-L-C circuit find out the peak current and resonance frequency.

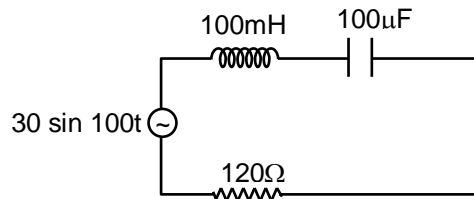

- (1) 2A, 10 Hz (2) 0.2A, 5Hz (3) 2A, 5Hz (4) 0.2A, 10 Hz

Ans. (2)

Sol. $Z = \sqrt{R^2 + (X_L - X_C)^2} = \sqrt{120^2 + (10 - 100)^2} = 150\Omega$

$$I_0 = \frac{V_0}{Z} = \frac{30}{150} = 0.2A$$

$$\omega = \frac{1}{\sqrt{LC}} = \frac{1}{\sqrt{10^{-1} \times 10^{-4}}} = \frac{1}{\sqrt{10^{-5}}} = 2\pi f$$

$$f = \frac{100}{2\pi\sqrt{10}} = \frac{100}{2 \times 10} = 5Hz$$

9. Two blocks of same mass M are connected to spring. A constant force F is applied on B. A moves away from B at some instant with accelerations a. Find the accelerations of A.

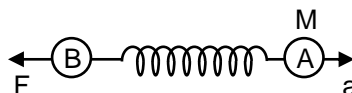

- (1) $\frac{F + Ma}{M}$ (2) $\frac{F - Ma}{M}$ (3) $\frac{M}{F + Ma}$ (4) $\frac{M}{F - Ma}$

Ans. (1)

Sol. $K_X = Ma$
 $F + K_X = Ma_B$
 $F + Ma = Ma_B$
 $a_B = \frac{F}{M} + a$

10. Find the time taken by block to reach bottom most point.

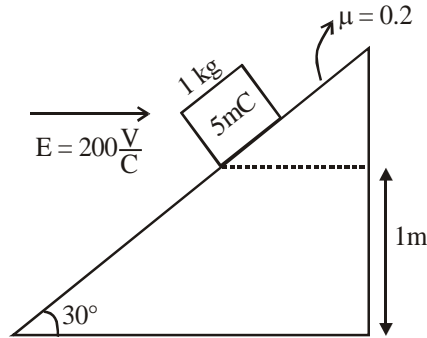

- (1) 0.92 s (2) 1.13 s (3) 2.1 s (4) 0.7 s

Ans. (2)

Sol.

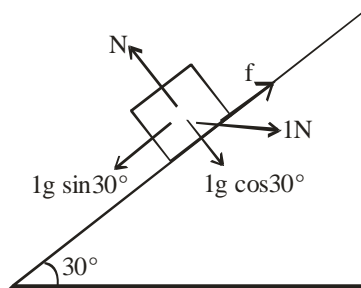

$$t = \left(\frac{1}{2} + 9.8 \frac{\sqrt{3}}{2} \right) \times 0.2$$

$$t = \sqrt{\frac{2s}{a}}$$

$$a = \frac{9.8}{2} - (0.2) \left(\frac{1}{2} + 9.8 \frac{\sqrt{3}}{2} \right)$$

$$= 4.9 - 1.79 \approx 3.1$$

$$= \frac{2}{\sqrt{a}} = \frac{2}{\sqrt{3.1}}$$

$$\approx 1.13 \text{ sec}$$

11. An unknown tuning fork 'A' when sounded with tuning fork B of 340 Hz gives 5 beats. When tuning fork A is filed then beat frequency become 2 beats. What will be the frequency of tuning fork 'A'.

- (1) 345 Hz (2) 335 Hz (3) 338 Hz (4) 342 Hz

Ans. (2)

Sol. On filing freq. increases so freq. of A would be 335. initially and on filing it would be 338 Hz. So beat freq. become 2 Hz.

12. A plane is moving in horizontal plane with 180 km/hr. Its wings span is 10 m. If $B = 2.5 \times 10^{-4}$ (Wb/m²) exists & angle of dip is 60° at a certain position. Find EMF induced between its wings span?

- (1) 108 mV (2) 66 mV (3) 50 mV (4) 80 mV

Ans. (1)

Sol. $\varepsilon = \beta \ell v \sin 60^\circ$

$$= 0.25 \times 10 \times 180 \times \frac{5}{18} \times \frac{\sqrt{3} \times 10^{-3}}{2} = 108.1 \text{ mV}$$

13. A metallic wire under tension T_1 has length ℓ_1 and under tension T_2 has length ℓ_2 . Find the original length of wire.

- (1) $\frac{T_1 \ell_1 + T_2 \ell_2}{T_1 - T_2}$ (2) $\frac{T_1 \ell_1 - T_2 \ell_2}{T_1 - T_2}$ (3) $\frac{\ell_1 + \ell_2}{2}$ (4) $\frac{T_1 \ell_2 - T_2 \ell_1}{T_1 - T_2}$

Ans. (4)

Sol. $\frac{T_1}{A} = \frac{y(\ell_1 - \ell)}{\ell}$

$$\frac{T_2}{A} = \frac{y(\ell_2 - \ell)}{\ell}$$

$$\frac{T_1}{T_2} = \frac{\ell_1 - \ell}{\ell_2 - \ell}$$

$$T_1 \ell_2 - T_1 \ell = T_2 \ell_1 - T_2 \ell$$

$$\frac{T_1 \ell_2 - T_2 \ell_1}{T_1 - T_2} = \ell$$

14. A resistor of length ℓ is stretched by 25 %. Find % change in its resistance?

- (1) 56% (2) 50% (3) 60% (4) 40%

Ans. (1)

Sol. $R_i = \frac{\rho \ell}{A}$

$$R_f = \frac{\rho(1.25\ell)}{(A/1.25)} = \frac{\rho \ell}{A} (1.25)^2$$

$$\therefore R_f = R_i (1.5625)$$

$$\therefore R_f = R_i (1+0.5625)$$

$$\therefore \frac{R_f - R_i}{R_i} = 0.5625$$

$$\therefore \% \frac{\Delta R}{R} = 56.25\%$$

15. If internal energy of an ideal gas is given by $U = 3 PV + 4$ where P & V are pressure and volume respectively, identify the type of gas.

- (1) Monoatomic (2) Diatomic
(3) Polyatomic (4) Monoatomic or Diatomic

Ans. (3)

Sol. $U = 3 PV + 4$

$$\frac{f}{2} PV = 3 PV + 4$$

$$f = 6 + \frac{8}{PV}$$

$f > 6 \therefore$ Polyatomic gas.

16. **Statement (1):** If a dipole is placed inside sphere then electric flux through it will be zero but electric field is not zero at any point of surface of sphere having radius R.

Statement (2): In a metallic conducting sphere of radius R having charge Q at distance $r < R$ electric field is zero but electric flux through sphere of radius r is not zero.

- (1) Statement (1) is correct, statement (2) is correct but not correct explanation.
(2) Statement (1) is correct, statement (2) is correct and it is correct explanation.
(3) Statement (1) is correct, statement (2) is wrong.
(4) Statement (1) is wrong and statement (2) is also wrong.

Ans. (3)

17. **Assertion:** Angular magnification of object and image is same in case of simple microscope.

Reason: We can place the object much closer to eye much less than 25 cm to get an enlarged image.

- (1) Assertion and Reason both are correct Reason explains Assertion.
(2) Assertion and Reason both are correct but Reason is not correct explanation of Assertion.
(3) Assertion is correct, Reason is incorrect.
(4) Assertion is incorrect, Reason is correct.

Ans. (3)

Sol.

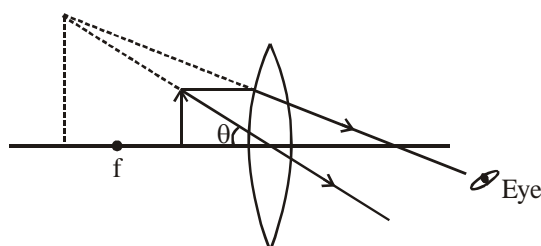

Both obtain same angle, since image can be at a distance greater than 25 cm, object can be moved closer to eye

18.

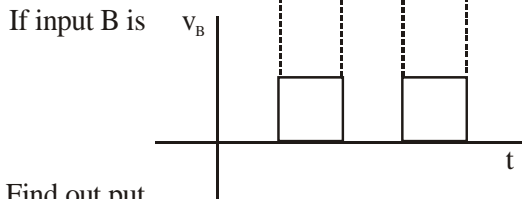
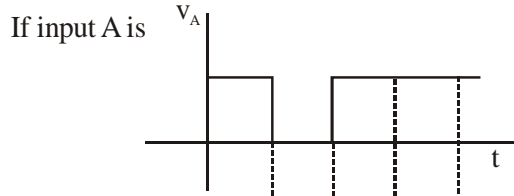
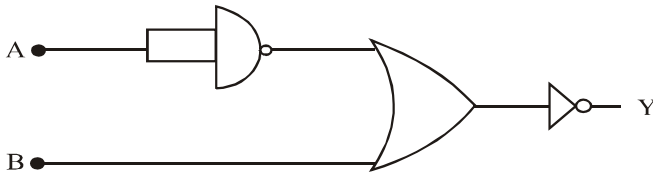

Find out put.

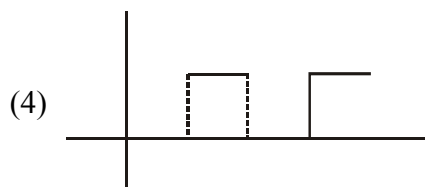
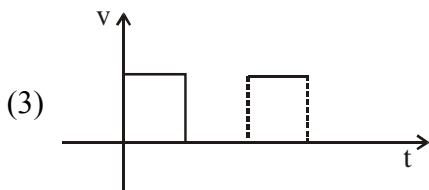
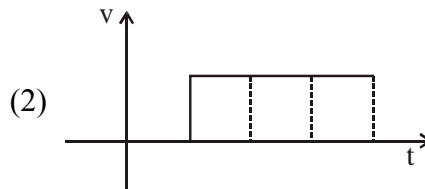
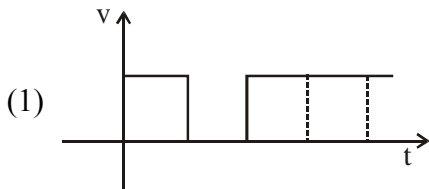

Ans. (3)

Sol. $y = \overline{\overline{A+B}} = A\overline{B}$

19. Gravitational field intensity at A and C are equal but less than point B [B lies on the surface of earth] If $OA : AB = x : y$, then what will be value of x. [x and y are in lowest form]

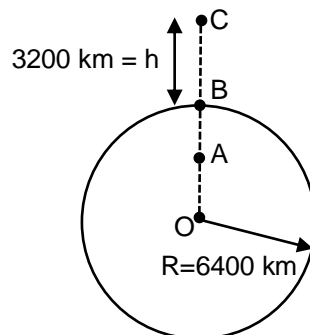

Ans. 4

Sol. $\frac{GM}{\left(\frac{3R}{2}\right)^2} = \frac{GM_r}{R^3}$

$OA = \frac{4R}{9} = r$

$AB = R - \frac{4R}{9} = \frac{5R}{9}$

$OA : AB$

$\frac{4R}{9} : \frac{5R}{9} \Rightarrow 4 : 5 = x : y$

$(x = 4)$

20. Time period of simple pendulum is T. in order to cover $\frac{5}{8}$ oscillation, it takes $\left(\frac{\alpha}{\beta}\right)^T$. Find α [it starts from mean position]

Ans. 7

Sol. Oscillation is $\left(\frac{1}{2} + \frac{1}{8}\right)$

For half oscillation, time required will be $\frac{T}{2}$

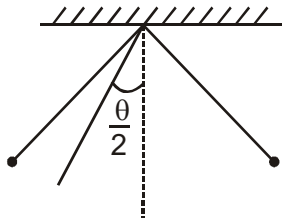

$\theta = \theta_0 \sin \omega t$

$\frac{1}{2} \sin \omega t$

$\omega t = \frac{\pi}{6}$

$\therefore t = \frac{T}{12}$

$\therefore \frac{T}{2} + \frac{T}{12} = \frac{7T}{12}$

21. A body is performing SHM of amplitude a and time period T. If the position where its speed becomes half of maximum is $\frac{\sqrt{x}A}{2}$, then find the value of x.

Ans. 3

Sol. $v = \omega\sqrt{A^2 - x^2}$

$$\frac{A\omega}{2} = \omega\sqrt{A^2 - x^2}$$

solving we get

$$x = \frac{\sqrt{3}A}{2}$$

22. A Zener diode circuit is given in figure. Find out current through Zener diode in mA.

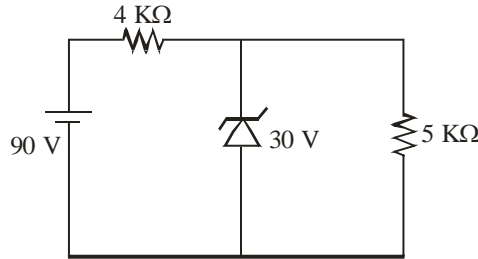

Ans. 9

Sol.

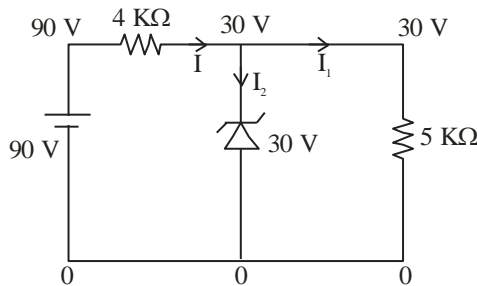

$$I = \frac{90 - 30}{4} = 15\text{mA}$$

$$I_1 = \frac{30}{5\text{K}\Omega} = 6\text{mA}$$

$$I_2 = 15\text{mA} - 6\text{mA} = 9\text{mA}$$

Ans. = 9

23. If 27 small drops, each of 10 volt are combined to form a big drop. What will be the potential of bigger drop in volt.

Ans. 90

Sol. $v = \frac{kq}{r} = 10\text{v}$

$$27 \times \frac{4}{3}\pi r^3 = \frac{4}{3}\pi R^3$$

$$R = 3r$$

$$v' = \frac{k \times 27q}{3r} = 90 \text{ volt}$$

24. An ideal gas follows a polytropic process $V = K T^{2/3}$ [K is a constant]. If Temp of gas is raised by 90°C , work done by gas is xR . Find x ?

Ans. 60

Sol. $V = K T^{2/3}$

$$V^{3/2} = (K)^{3/2} T$$

$$\therefore TV^{-3/2} = \text{const.} \Rightarrow x-1 = -3/2$$

$$\therefore x = -1/2$$

$$\therefore \omega = \frac{nR\Delta T}{-x+1}$$

$$= \frac{1(R)(90)}{1 + \frac{1}{2}} = 60R$$

25. Two beams of different intensity, such that photon energy in 1st is twice the work function and in other one is ten times the work function are incident on metal plate. If the ratio of maximum speed of photoelectron in the two cases is $x : y$, find x .

Ans. 1

Sol. Case-1.

$$2\phi - \phi = \frac{1}{2}mv_1^2 \quad \dots(i)$$

Case -2

$$10\phi - \phi = \frac{1}{2}mv_2^2 \quad \dots(ii)$$

Dividing (i) and (ii)

$$\frac{\phi}{9\phi} = \frac{v_1^2}{v_2^2}$$

$$\frac{1}{9} = \frac{v_1}{v_2}$$

$$\therefore x = 1$$

26. An aeroplane is flying horizontally with velocity 180 km/h. Magnetic field of earth is $B = 2.5 \times 10^{-4}$ T and dip angle at that place is 60° . If the span of wings is 10 m. Find EMF induced in the wings.

Ans. 108

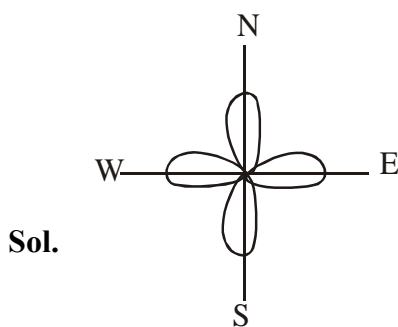

$$\Sigma = B \perp v\ell$$

$$\sin 60^\circ = \frac{Bv}{B}$$

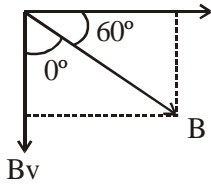

$$\frac{\sqrt{3}}{2} = \frac{Bv}{B}$$

$$Bv = \frac{\sqrt{3}}{2} B$$

$$E = \frac{\sqrt{3}}{2} B l v$$

$$= \frac{\sqrt{3}}{2} \times 2.5 \times 10^{-4} \times 10 \times 180 \times \frac{5}{18}$$

$$= \frac{\sqrt{3}}{2} \times 2.5 \times 5 \times 10^{-2}$$

$$= 10.825 \times 10^{-2}$$

$$= 108 \text{ mv}$$

27. A source of light S is placed midway between mirror and line of motion of a person. Find the maximum distance m cm upto which person can see the image of object.

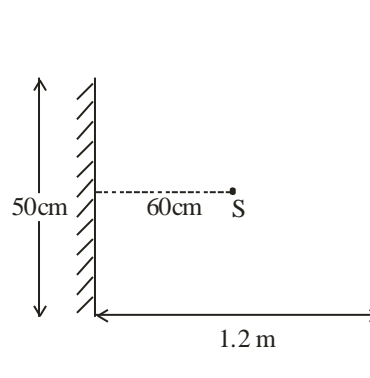

Ans. 150

Sol.

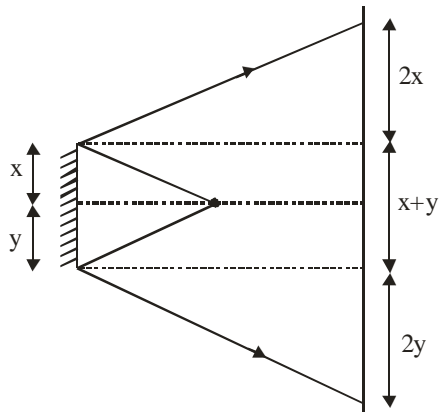

$$\begin{aligned}
 &= 3(x + y) \\
 &= 3(50) \\
 &= 150 \text{ cm}
 \end{aligned}$$

28. Coming soon.

Ans.

Sol.

29. Coming soon.

Ans.

Sol.

30. Coming soon.

Ans.

Sol.